



N-channel 30V, 50A, DFN5*6-8 Power MOSFET 功率場效應管

■ **Features 特點**

Low on-resistance and maximum DC current capability 低導通電阻和最大直流電流能力

Super high density cell design 超高元胞密度設計

$R_{DS(ON)} < 9m\Omega @ V_{GS}=10V$

$R_{DS(ON)} < 17m\Omega @ V_{GS}=5V$

■ **Applications 應用**

Power Management 電源管理

PWM Applications 脉宽调制

Load Switch 負載開關應用

■ **Internal Schematic Diagram 內部結構**

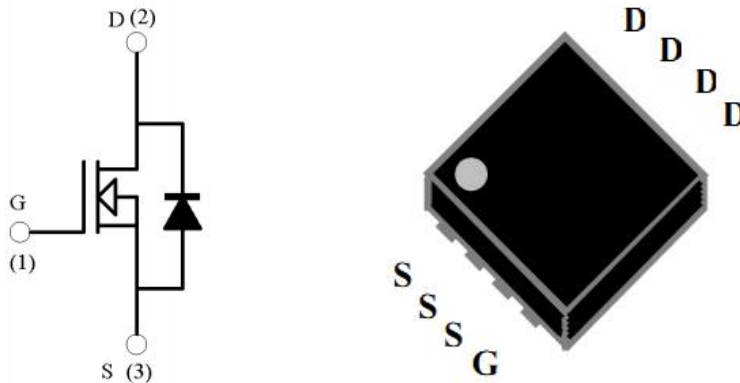

■ **Absolute Maximum Ratings 最大額定值**

Characteristic 特性參數	Symbol 符號	Rat 額定值	Unit 單位
Drain-Source Voltage 漏極-源極電壓	BV_{DSS}	30	V
Gate- Source Voltage 柵極-源極電壓	V_{GS}	± 20	V
Drain Current (continuous) 漏極電流-連續	I_D (at $TC = 25^\circ C$)	50	A
Drain Current (pulsed) 漏極電流-脈沖	I_{DM}	200	A
Single Pulse Avalanche Energy 雪崩能量	E_{AS}	90*	mJ
Total Device Dissipation 總耗散功率	P_{TOT} (at $TC = 25^\circ C$)	50	W
Thermal Resistance Junction-Case 熱阻	$R_{\theta JC}$	3	$^\circ C/W$
Junction/Storage Temperature 結溫/儲存溫度	T_J, T_{stg}	-55~175	$^\circ C$

* E_{AS} condition: $L=0.5mH$, $R_g=25\Omega$, $V_D=30V$, $V_{GS}=10V$, I_D rating 20A



■ Electrical Characteristics 電特性

($T_A=25^{\circ}\text{C}$ unless otherwise noted 如無特殊說明，溫度為 25°C)

Characteristic 特性參數	Symbol 符號	Min 最小值	Typ 典型值	Max 最大值	Unit 單位
Drain-Source Breakdown Voltage 漏極-源極擊穿電壓($I_D=250\mu\text{A}, V_{GS}=0\text{V}$)	BV_{DSS}	30	—	—	V
Gate Threshold Voltage 柵極開啓電壓($I_D=250\mu\text{A}, V_{GS}=V_{DS}$)	$V_{GS(th)}$	1	1.5	2.5	V
Zero Gate Voltage Drain Current 零柵壓漏極電流($V_{GS}=0\text{V}, V_{DS}=30\text{V}$)	I_{DSS}	—	—	1	μA
Gate Body Leakage 柵極漏電流($V_{GS}=\pm 20\text{V}, V_{DS}=0\text{V}$)	I_{GSS}	—	—	± 100	nA
Static Drain-Source On-State Resistance 静态漏源導通電阻($I_D=20\text{A}, V_{GS}=10\text{V}$) ($I_D=15\text{A}, V_{GS}=5\text{V}$)	$R_{DS(ON)}$	—	7.2 11	9 17	$\text{m}\Omega$
Source Drain Current 源極-漏極電流	I_{SD}	—	—	50	A
Diode Forward Voltage Drop 內附二極管正向壓降($I_{SD}=20\text{A}, V_{GS}=0\text{V}$)	V_{SD}	—	—	1.2	V
Input Capacitance 輸入電容 ($V_{GS}=0\text{V}, V_{DS}=15\text{V}, f=1\text{MHz}$)	C_{ISS}	—	1050	—	pF
Common Source Output Capacitance 共源輸出電容($V_{GS}=0\text{V}, V_{DS}=15\text{V}, f=1\text{MHz}$)	C_{OSS}	—	145	—	pF
Reverse Transfer Capacitance 回饋電容($V_{GS}=0\text{V}, V_{DS}=15\text{V}, f=1\text{MHz}$)	C_{RSS}	—	120	—	pF
Total Gate Charge 柵極電荷密度 ($V_{DS}=25\text{V}, I_D=12\text{A}, V_{GS}=10\text{V}$)	Q_g	—	22	—	nC
Gate Source Charge 柵源電荷密度 ($V_{DS}=25\text{V}, I_D=12\text{A}, V_{GS}=10\text{V}$)	Q_{gs}	—	4	—	nC
Gate Drain Charge 柵漏電荷密度 ($V_{DS}=25\text{V}, I_D=12\text{A}, V_{GS}=10\text{V}$)	Q_{gd}	—	7	—	nC
Turn-On Delay Time 開啓延遲時間 ($V_{DS}=15\text{V}, I_D=15\text{A}, R_{GEN}=3.3\Omega, V_{GS}=10\text{V}$)	$t_{d(on)}$	—	7	—	ns
Turn-On Rise Time 開啓上升時間 ($V_{DS}=15\text{V}, I_D=15\text{A}, R_{GEN}=3.3\Omega, V_{GS}=10\text{V}$)	t_r	—	22	—	ns
Turn-Off Delay Time 關斷延遲時間 ($V_{DS}=15\text{V}, I_D=15\text{A}, R_{GEN}=3.3\Omega, V_{GS}=10\text{V}$)	$t_{d(off)}$	—	30	—	ns
Turn-On Fall Time 開啓下降時間 ($V_{DS}=15\text{V}, I_D=15\text{A}, R_{GEN}=3.3\Omega, V_{GS}=10\text{V}$)	t_f	—	5	—	ns

■ TYPICAL CHARACTERISTIC CURVE

典型特性曲线

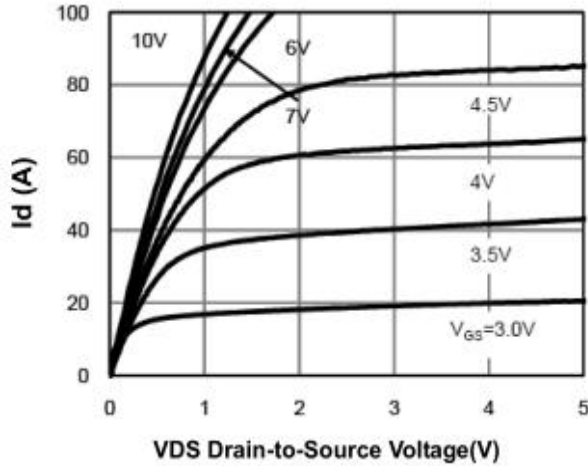

Fig 1: Output Characteristics

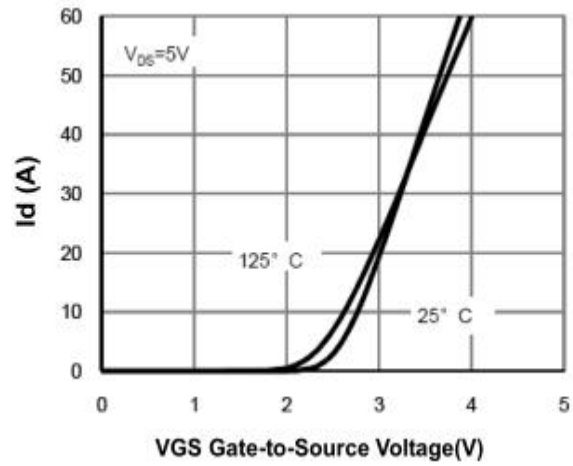

Figure 2: Transfer Characteristics

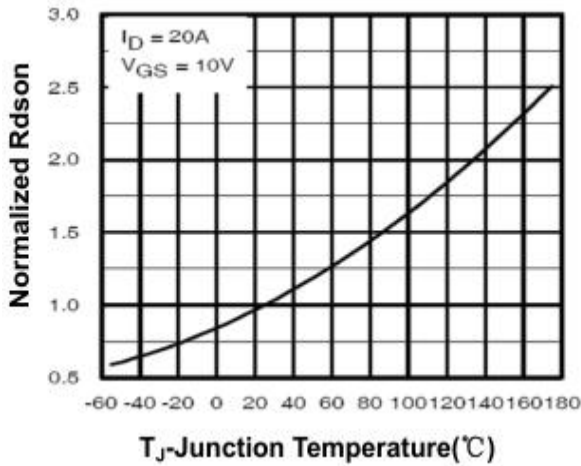

Figure 3: On-Resistance vs. T_j

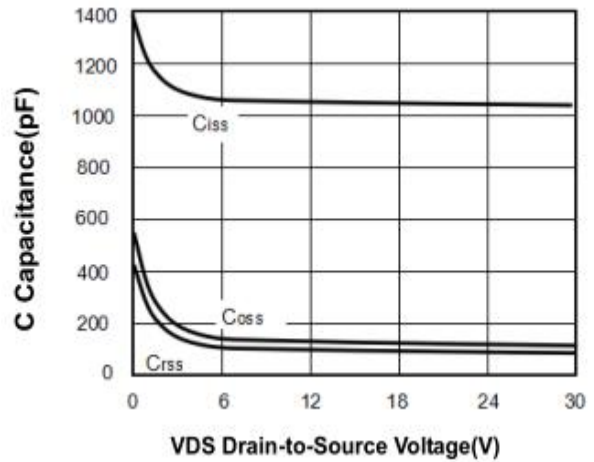

Figure 4: Capacitance

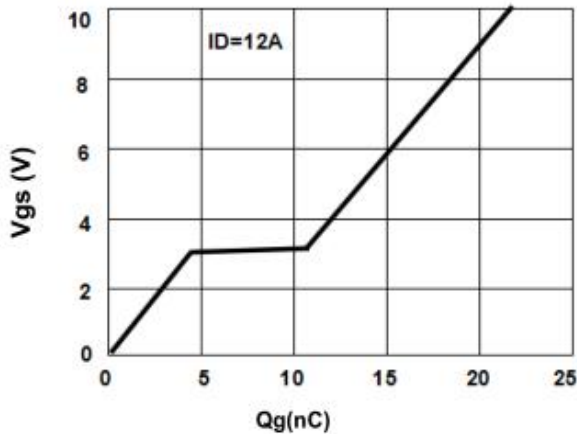

Figure 5: Gate-Charge Characteristics

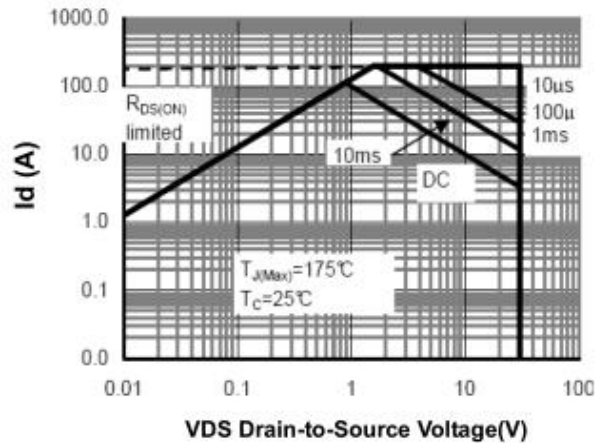
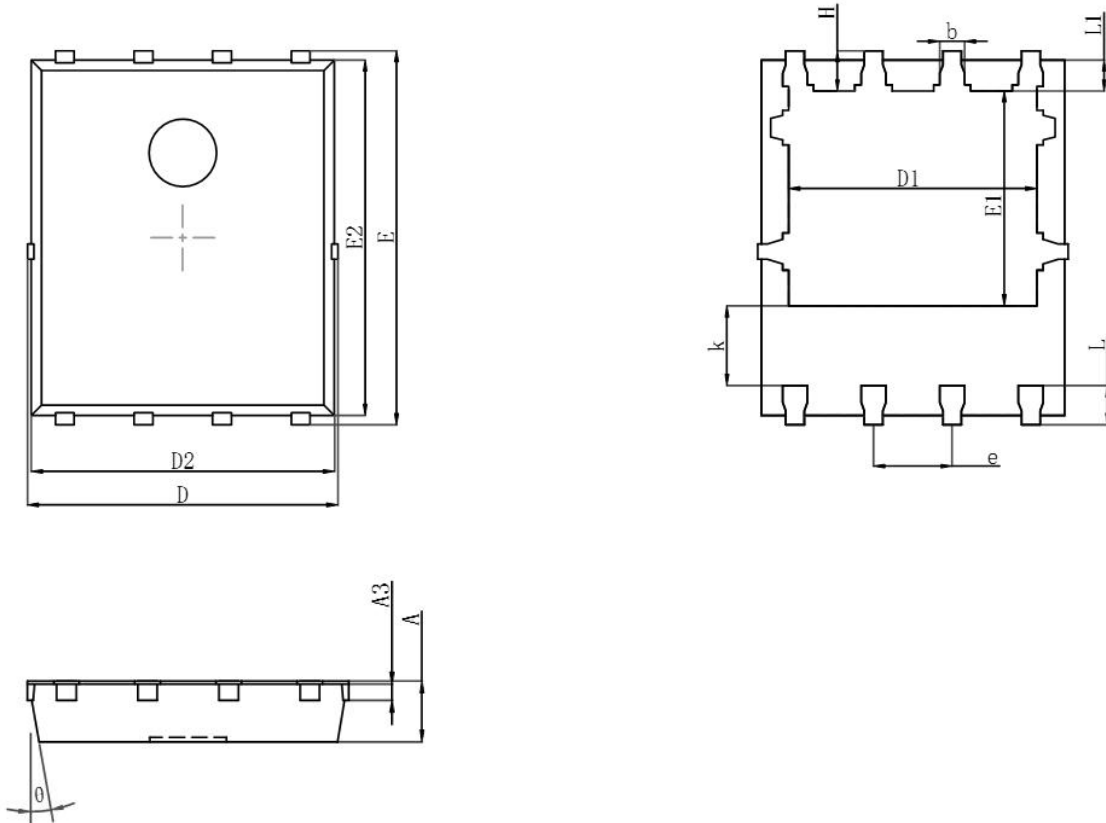

Figure 6: Safe Operating Area



■ DIMENSION 外形封裝尺寸



Symbol	Dimensions In Millimeters		Dimensions In Inches	
	Min.	Max.	Min.	Max.
A	0.900	1.000	0.035	0.039
A3	0.254REF.		0.010REF.	
D	4.944	5.096	0.195	0.201
E	5.974	6.126	0.235	0.241
D1	3.910	4.110	0.154	0.162
E1	3.375	3.575	0.133	0.141
D2	4.824	4.976	0.190	0.196
E2	5.674	5.826	0.223	0.229
k	1.190	1.390	0.047	0.055
b	0.350	0.450	0.014	0.018
e	1.270TYP.		0.050TYP.	
L	0.559	0.711	0.022	0.028
L1	0.424	0.576	0.017	0.023
H	0.574	0.726	0.023	0.029
θ	10°	12°	10°	12°