



**N-channel 100V, 62A, TO-252 Power MOSFET 功率場效應管**

■ **Features 特點**

Low on-resistance and maximum DC current capability 低導通電阻和最大直流電流能力

Super high density cell design 超高元胞密度設計

$R_{DS(ON)}$  TYP 7.2mΩ @ VGS=10V

$R_{DS(ON)}$  TYP 10.8mΩ @ VGS=4.5V

■ **Applications 應用**

Power Management in Note book 筆記本電源管理

Portable Equipment 便攜式設備

Battery Powered System 電池電源系統

Quick Charger 快速充電器

Load Switch 負載開關應用

■ **Internal Schematic Diagram 內部結構**

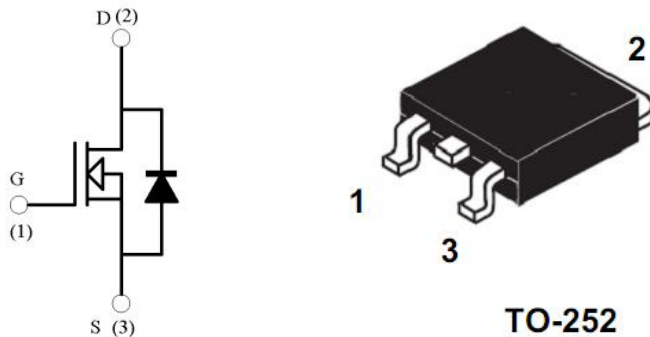

■ **Absolute Maximum Ratings 最大額定值**

Characteristic 特性參數	Symbol 符號	Rat 額定值	Unit 單位
Drain-Source Voltage 漏極-源極電壓	$BV_{DSS}$	100	V
Gate- Source Voltage 柵極-源極電壓	$V_{GS}$	+20/-12	V
Drain Current (continuous)漏極電流-連續	$I_D$ (at TC = 25°C)	62	A
Drain Current (pulsed)漏極電流-脈沖	$I_{DM}$	220	A
Total Device Dissipation 總耗散功率	$P_{TOT}$ (at TC = 25°C)	75	W
Thermal Resistance Junction-Ambient 熱阻	$R_{\theta JA}$	2	°C/W
Junction/Storage Temperature 結溫/儲存溫度	$T_J, T_{stg}$	-50~175	°C



■ Electrical Characteristics 電特性

( $T_A=25^{\circ}\text{C}$  unless otherwise noted 如無特殊說明，溫度為  $25^{\circ}\text{C}$ )

Characteristic 特性參數	Symbol 符號	Min 最小值	Typ 典型值	Max 最大值	Unit 單位
Drain-Source Breakdown Voltage 漏極-源極擊穿電壓( $I_D=250\mu\text{A}, V_{GS}=0\text{V}$ )	$BV_{DSS}$	100	—	—	V
Gate Threshold Voltage 柵極開啓電壓( $I_D=250\mu\text{A}, V_{GS}=V_{DS}$ )	$V_{GS(th)}$	1	1.6	2.5	V
Zero Gate Voltage Drain Current 零柵壓漏極電流( $V_{GS}=0\text{V}, V_{DS}=100\text{V}$ )	$I_{DSS}$	—	—	1	$\mu\text{A}$
Gate Body Leakage 柵極漏電流( $V_{GS}=+20/-12\text{V}, V_{DS}=0\text{V}$ )	$I_{GSS}$	—	—	$\pm 100$	nA
Static Drain-Source On-State Resistance 静态漏源導通電阻( $I_D=15\text{A}, V_{GS}=10\text{V}$ ) ( $I_D=8\text{A}, V_{GS}=4.5\text{V}$ )	$R_{DS(ON)}$	—	7.2 10.8	9.2 14	$\text{m}\Omega$
Source Drain Current 源極-漏極電流	$I_{SD}$	—	—	62	A
Diode Forward Voltage Drop 內附二極管正向壓降( $I_{SD}=10\text{A}, V_{GS}=0\text{V}$ )	$V_{SD}$	—	0.78	1.2	V
Input Capacitance 輸入電容 ( $V_{GS}=0\text{V}, V_{DS}=50\text{V}, f=1\text{MHz}$ )	$C_{ISS}$	—	—	2330	pF
Common Source Output Capacitance 共源輸出電容( $V_{GS}=0\text{V}, V_{DS}=50\text{V}, f=1\text{MHz}$ )	$C_{OSS}$	—	—	465	pF
Reverse Transfer Capacitance 回饋電容( $V_{GS}=0\text{V}, V_{DS}=50\text{V}, f=1\text{MHz}$ )	$C_{RSS}$	—	—	21	pF
Total Gate Charge 總柵電荷密度 ( $V_{DS}=50\text{V}, I_D=20\text{A}, V_{GS}=10\text{V}$ )	$Q_g$	—	9.8	—	nC
Gate Source Charge 柵源電荷密度 ( $V_{DS}=50\text{V}, I_D=20\text{A}, V_{GS}=10\text{V}$ )	$Q_{gs}$	—	6.8	—	nC
Gate Drain Charge 柵漏電荷密度 ( $V_{DS}=50\text{V}, I_D=20\text{A}, V_{GS}=10\text{V}$ )	$Q_{gd}$	—	10	—	nC
Turn-On Delay Time 開啓延遲時間 ( $V_{DS}=50\text{V}, I_D=10\text{A}, R_{GEN}=6\Omega, V_{GS}=10\text{V}$ )	$t_{d(on)}$	—	15	—	ns
Turn-On Rise Time 開啓上升時間 ( $V_{DS}=50\text{V}, I_D=10\text{A}, R_{GEN}=6\Omega, V_{GS}=10\text{V}$ )	$t_r$	—	8	—	ns
Turn-Off Delay Time 關斷延遲時間 ( $V_{DS}=50\text{V}, I_D=10\text{A}, R_{GEN}=6\Omega, V_{GS}=10\text{V}$ )	$t_{d(off)}$	—	22	—	ns
Turn-On Fall Time 開啓下降時間 ( $V_{DS}=50\text{V}, I_D=10\text{A}, R_{GEN}=6\Omega, V_{GS}=10\text{V}$ )	$t_f$	—	6	—	ns

■ TYPICAL CHARACTERISTIC CURVE

典型特性曲线

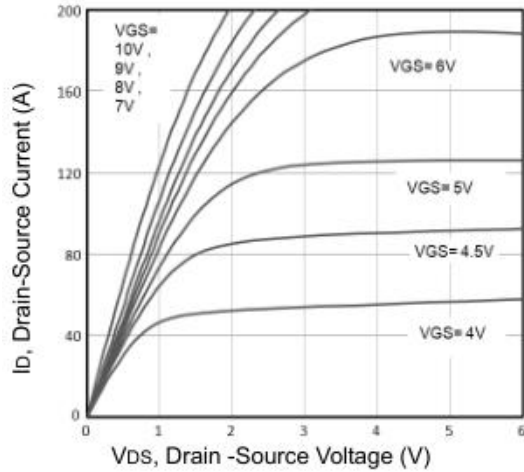

Fig 1: Output Characteristics

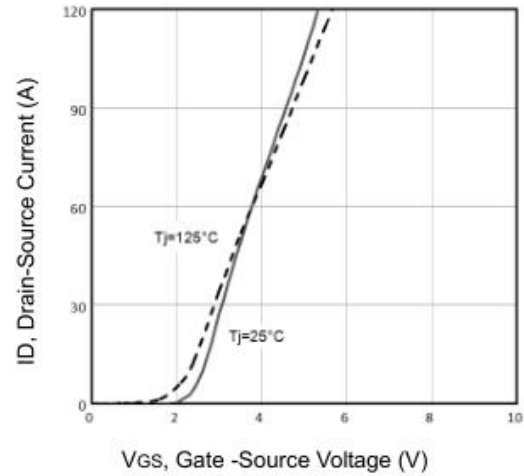

Figure 2: Transfer Characteristics

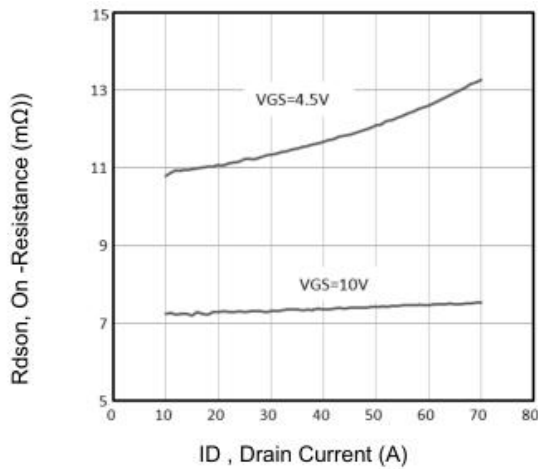

Figure 3: On-Resistance vs. ID & VGS

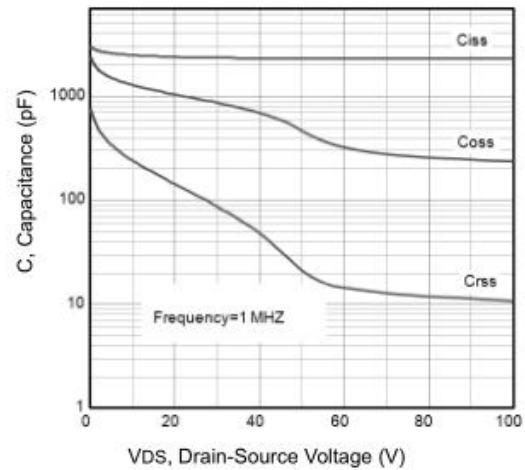

Figure 4: Capacitance Characteristics

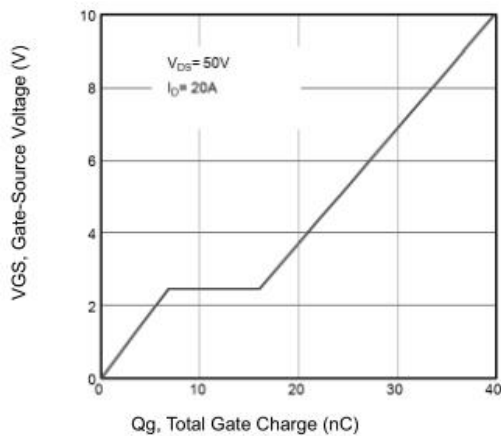

Figure 5: Gate-Charge Characteristics

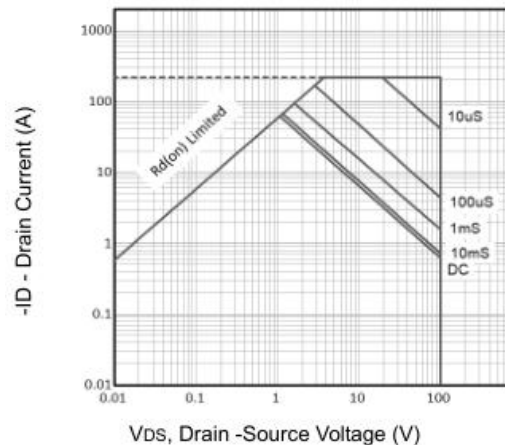
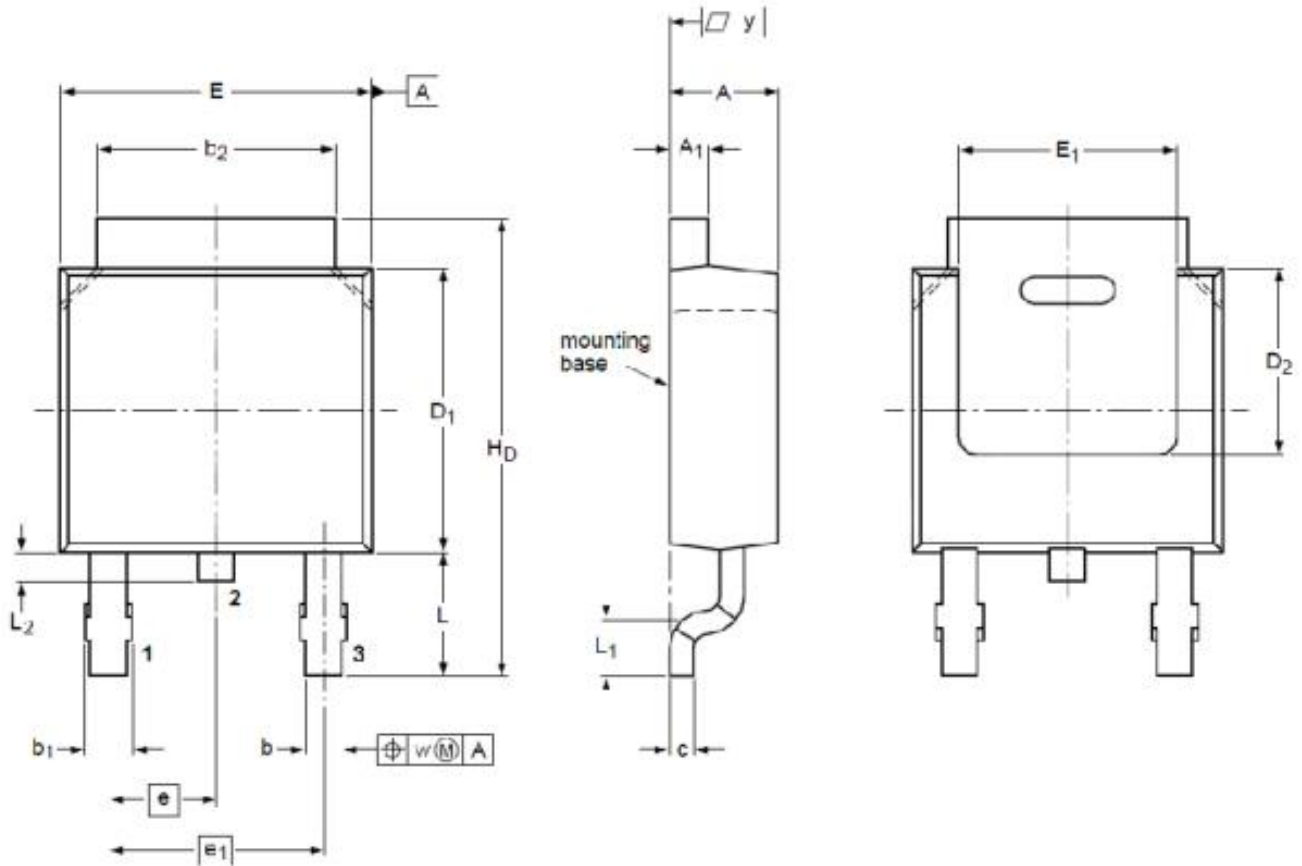

Figure 6: Safe Operating Area



■DIMENSION 外形封裝尺寸

Unit 單位:mm 毫米



Symbol	Min	Typ	Max	Symbol	Min	Typ	Max
A	2.22	2.30	2.38	A <sub>1</sub>	0.4	0.53	0.65
b	0.68	0.78	0.89	b <sub>1</sub>	0.90	0.98	1.10
b <sub>2</sub>	5.20	5.33	5.55	c	0.45	0.5	0.55
D <sub>1</sub>	5.98	6.10	6.22	D <sub>2</sub>	--	4.00	--
E	6.47	6.60	6.73	E <sub>1</sub>	5.10	5.28	5.45
e	--	2.28	--	e <sub>1</sub>	--	4.57	--
H <sub>D</sub>	9.60	10.08	10.40	L	2.75	2.95	3.05
L <sub>1</sub>	--	0.50	--	L <sub>2</sub>	0.50	--	1.10
w	--	0.20	--	y	0.20	--	--